

This is not an ADB material. The views expressed in this document are the views of the author/s and/or their organizations and do not necessarily reflect the views or policies of the Asian Development Bank, or its Board of Governors, or the governments they represent. ADB does not guarantee the accuracy and/or completeness of the material's contents, and accepts no responsibility for any direct or indirect consequence of their use or reliance, whether wholly or partially. Please feel free to contact the authors directly should you have queries.



# Regional Rapid Transit System in National Capital Region (NCR) of India

## *Overview of Project Monitoring Platform 'SPEED'*

OCTOBER 2023

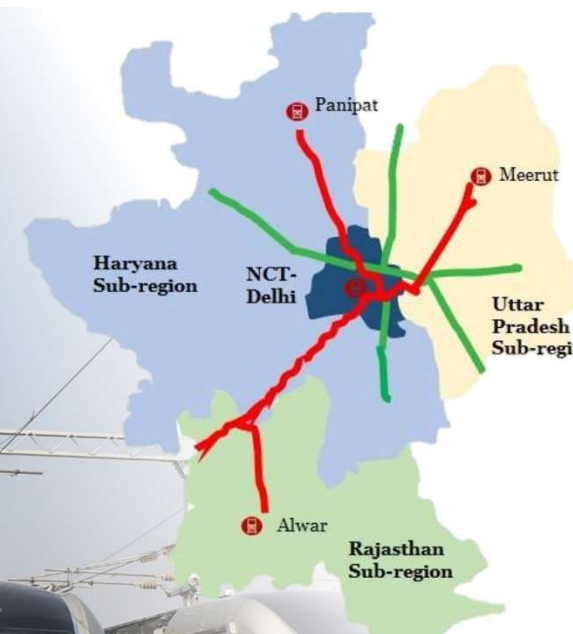

# NCRTC: Joint venture between Government of India (GoI) & State governments is implementing India's first semi-high speed regional rail



Inadequate regional mobility in NCR is constraining growth

RRTS is a key strategic intervention of government & is being implemented by NCRTC



**Unmanageable Urban Sprawl**

- Lacking regional Public Transport - low frequency, lack of integration - Multiple interchanges



**Pollution**

- 40% increase in vehicular pollution - 2010 & 2018
- Road vehicles contribute as high as 41% of the pollution



**Congestion**

- Vanishing off-peak hours
- 63% share of Private Transport



**Accidents**

- In 2019 - highest # of deaths in Delhi - 1463 (highest among cities with 50 million plus population)\*



**NCRTC**

- NCRTC was incorporated in 2013
- 3 prioritized corridors
  - Delhi - Meerut (82km)
  - Delhi - SNB (107Km)
  - Delhi - Panipat (103km)



**Regional Rapid Transit System (RRTS)**

- Delhi-Meerut corridor was sanctioned in March-2019
- 17Kms section ready for commissioning
- Full corridor commissioning by June-2025



**RAPIDX Trains**

- RRTS train operation services called RAPIDX
- Separate Ladies Coach
- Dedicated Business Class

RRTS is a Rail based **semi-high speed, high-capacity service** delivering a comfortable and safe commuter experience

Salient features of RRTS' offerings

Design speed of 180 kmph  
(Delhi to Meerut-82kms in less than an hour)

Train every ~5-10 min. & serving traffic nodes every 5-10 kms

Interoperable Corridors & Multimodal Integration

Universal Access & Dedicated Women Coach

High capacity, comfortable journey, airline seating

Weather-proof from rains, fog etc.

Reduced Land use for high throughput

Commuter friendly information system

RRTS trains will travel at 3 times the average speed of Metro in India

# Leveraging Technology for on-time delivery of project

## Project Planning & Monitoring Tools

- Primavera P6
- SPEED (In-House)

## Building Information Modeling (BIM) & GIS

- Collaborative design
- 3D visualisation & Simulations
- Integration with GIS

## Documentation

- CCTV/ PTZ Cameras
- Time Lapsed Video
- UAV (Drone)

## Common Data Environment (CDE)

- BIM enabled Electronic Document Management System (EDMS)

## Mobile Applications



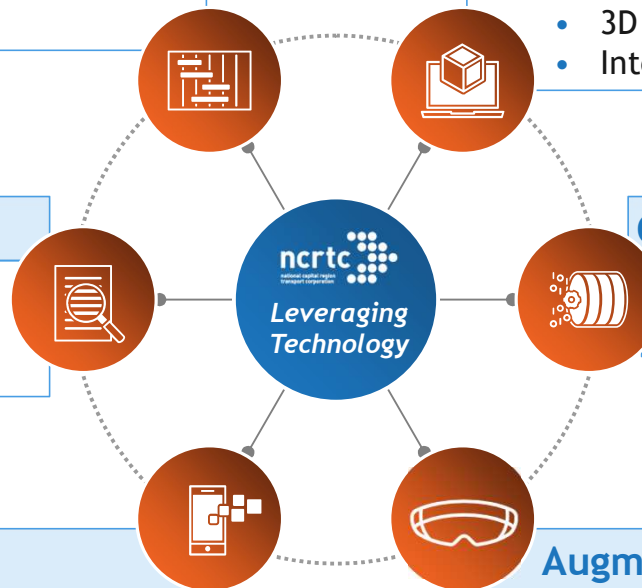

- Employee attendance (Gati App) (In-house)
- Quality Control (QC) App (In-house)
- RAPIDX Connect

## Augmented/Virtual Reality (AR/VR)

- Real-time visualizations
- Team collaboration



# Objective for developing an In-house Project Monitoring tool

-  **Timely identification and mitigation of potential risks** - mainly involving third parties - creating dependencies with construction activities
-  Available tools in the market are more contractor-centric - **lack project owner's perspective**
-  **Projects owner** best placed to manage pre-construction risks
-  **Customised modules** - improved planning/ scheduling, cost control
-  **Enhanced collaboration** and enabling remote working
-  Live on-site information to facilitate **decision making**

Identification and managing risks leads to achieving project timelines

SPEED is an enhanced and comprehensive customizable project tool

## Systematic Program Evaluation for Efficient Delivery (SPEED)



**All important project aspects covered** - Pre-construction, Construction, Cost, Meetings, Quality & Safety, etc.



Can be **Integrated** with 3rd party applications like **Common Data Environment (CDE), Power-BI, Primavera, etc.**



Can be **customized** for Buildings, Railways, Highways or any other infrastructure project



Ease of **usability and accessibility** - **Mobile friendly** user-interface



**Ease of working** - Can be used effectively by **minimum training**



**Caters to project owner's perspective** for large infrastructure projects

# SPEED Key Modules cover the entire horizon of the project management





# Pre-Construction Module | SPEED enables to identify & capture key dependencies with monitorable stages & maintain proper documentation



Requirements of **land/utilities** across the alignment can be captured

## Pre-Construction Module

Progress of Land/Utilities/Activities

Filter to select utility type

Idf	Type	Agency	Ch.Mtr.	Details/Requirement	Stage-wise Status	Remarks	Documents	Target/Status	Entry-by/Time
1246	Tree - General	Deposit-Work	19640-20100	94 No.	Progress			GGMIT 11:19 57:53	
694	Tree - General	GHAZIABAD NAGAR NIGAM	19690-23340	285 No.	Progress			GGMIT 18:11:19 11:57:53	
38	Electrical EHT-132 KV	UPPTCL ETD-I, GZB	20650-20650	1 No. Overhead	Survey Proc.Fee Est.Recd. Est.Proc. Pay-1st Tender Pay-2nd LOI Clearance	Work completed on 09.02.2020	↑↑↑↑	TAELE 20/02/20 10:48:26	
36	Electrical EHT-220 KV	UPPTCL ETD-I, GZB	20690-20690	1 No. Overhead	Survey Proc.Fee Est.Recd. Est.Proc. Pay-1st Tender Pay-2nd LOI Clearance Agreement Procurement Exec Recon	Work completed on 22.02.2020	↑↑↑↑	TAELE 02/03/20 09:40:53	

Related documents and correspondence

Different Stages of utilities

Other output reports from the data

Select Utility/Activity Type/Sub-Type

- Land (all Sub-Types)
- Civil/Part/Access/Drainage
- Civil/Temp/Water
- Civil/Part/MSCC
- Civil/Temp/MSCC
- Part/Part/MSCC
- Part/Part/MSCC/Asst
- Part/Temp/MSCC
- MSCC
- Electrical (all Sub-Types)
- EHT-132 KV
- EHT-220 KV
- EHT-132 KV

Measurable details like Chainage, Agency, Quantity can be captured

Complete **Transparency** & Information sharing

Different activity stages for **proper monitoring**



# Construction Module | Monitor the real time status of all construction activities; easy data visualization tools available (1/2)

- **Work Breakdown Structure (WBS)** - Monitorable activities of project are created in the form of WBS
- **Activity Detailing** - Associated details like scope, schedule dates, and type of activity like Pre-cast/Cast In-Situ, etc. can be captured
- **Daily progress update - by field offices** - Activities are updated online, directly from field offices
- **Flexible to use & Customizable** - depending on the type of infrastructure project

## Easy to track construction progress via data visualization

- **Single source of information** - no requirement of physical reports
- **Capture data at minute level** - Drawing Status and Pour Cards are also captured
- **Flexibility to capture different type of output** - based on use-case like package-wise, activity wise, etc.

Different Filters like Corridor, Stage, Department, Package can be selected

Corridor	Stage	Construction	Dept	GNL	Package	Element	Activity-Code	Pre-Act	Parent-Id	Van-Finish	BIM-ID	Actual-Start	Actual-Finish
...	...	...	...	...	...	...	...	...	...	...	...	...	...

Click Here to Select Loc

Location-Seq	Location-Name	Parent-Id	Package
EM0001	Ceiling Top (PI) Viaduct	...	...
EM0002	Viaduct before SBB	...	...
EM0003	Station	...	...
EM0004	Viaduct between SBB to G2B upto Mahan Nagar	...	...
EM0005	Viaduct between SBB to G2B after Mahan Nagar	...	...
EM0006	Shaded Station Metro crossing Special Span	...	...

Location/Section under respective package to be selected to add/edit activities

Viaduct

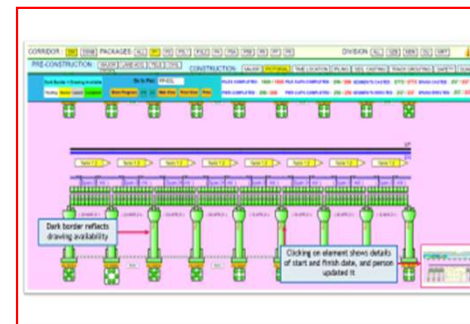

Station

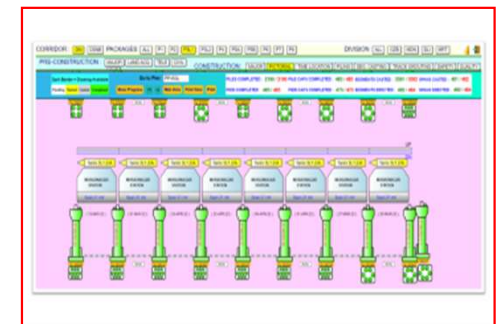



# Quality Control & Safety & Environment Status | Single window management of Quality, Safety & Environment

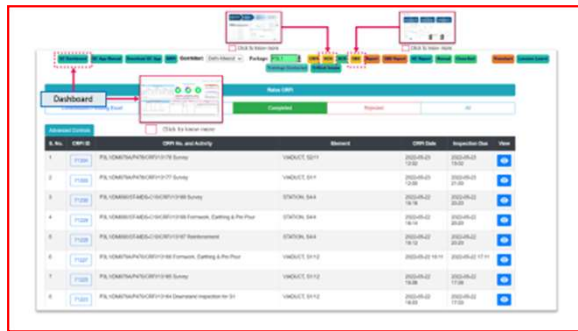

## Quality Report:

- Online generation and approval of Request for Inspection (RFI), NCR/NCN, etc.
- Single Window Management
- Transparency in Data

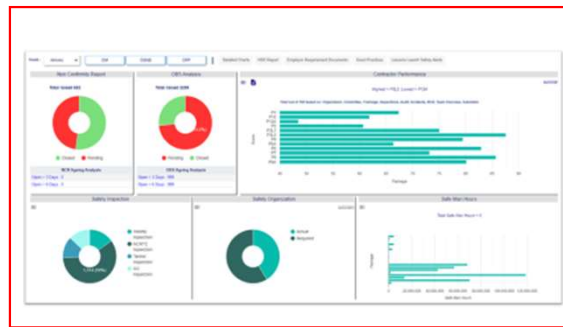

## Safety Report:

- Status of safety parameters like NCR, Observations, contractor performance, Mandays worked/lost, Incident count & reports
- Single window for capturing and analyzing safety data for packages/field-office wise



## Environment Report:

- Comprehensive dashboard covering major environment parameters
- Status of monitored parameters like PM10, PM2.5, SO2, NO2, etc.
- Status of tree cutting and tree plantation along with survival nos.



# Cost Monitoring Module | Comparison of Approved / Estimated / Awarded / Actual cost

Item-wise Approved project cost is tracked against various costs

Detailed Project Report - Costs

97-NCRTC-SREXPLG]

DPR sub-head wise breakup

Delhi-Meerut

Show/Refresh List

Exit

Search-Approval

Item-No.	Description	Total-Cost (INR Cr.)	Approval (INR Cr.)	Tendered (INR Cr.)	Awarded (INR Cr.)	Bill/Payment Status (INR Cr.)					Completed (INR Cr.)
						Submitted	Certified	Paid	Advance	Escalation	
1	Land	2073	1971.1391	0	508.5843	0	492.076	0	1.2764	493.3524	0
2	Civil works, Alignment and formation (excl. Stations & Depot)	5624	6313.4165	0	5605.9545	0	4698.9566	115.579	873.1326	5687.6682	0
3	Station Building	3059	2340.0372	0	2358.9753	0	1186.7674	-30.7109	139.0806	1295.1371	0
4	E&M Works	504	618.2302	0	537.553	0	49.7154	17.6784	5.2835	72.6773	0
5	Depot-cum-Workshop	320	595.5059	0	449.591	0	176.9819	2.4315	25.2855	204.6989	0
6	Permanent Way	966	1122.4224	0	982.8984	0	422.5095	35.7576	58.9946	517.2617	0
7	Traction & Power Supply incl. OHE, ASS etc.	1179	995.3609	0	740.494	0	205.5632	21.973	19.7304	247.2666	0
8	Signalling and Telecom. (incl. Depot lines)	1342	125.535	0	969.8033	0	169.2541	73.4211	0	242.6753	0
9	Automatic fare collection	10	62	0	227	0	6.9244	0	0	6.9244	0

Different corridors can be selected

List & details of Admin approvals obtained against each head can be viewed

List & details of LOAs booked against each head can be viewed

Details of Bills booked against each head can be viewed

End-to-end online process of Estimate approval, LOA Generation & Bill processing



# Review Meeting Module | Online Agenda and Minutes of Meeting

- Meetings are decision support system and brings synergy in the organization
- Conducted at various levels like -
  - Weekly MD review meeting
  - Departments meeting
  - Project site meetings



Online live rolling agenda



Minutes with auto archiving



Tagging officers for reply

**Update/Manage Position for Reviews/Meetings**

Chair	Chair-Name	Div.
MD	MD Level Meeting	00
MD.2.1	MD-Review-with-CPM/GZB	00
MD.2.1.2	MD-Review-with-CPM/GZB for Pkg 5A (Duhai Depot)	00
MD.2.2	MD-Review-with-RS and S&T	00
MD.3.1	MD-Review-with-CPM/MDNR	00
MD.3.2	MD-Review-with-CE/Track	00
MD.4.1	MD-Review-with-CPM/Delhi	00
MD.4.2	MD-Review-with-CE/G	00
MD.4.3	MD-Review-with-Electrical-Groups	00
MD.5.1	MD-Review-with-CPM/Meerut	00

**Details of various meetings are mentioned. By clicking date wise schedule can be viewed**

Mtg Id	Mtg Date	Status	Mtg Title
00.186	2023-05-08	N	Coordination Meeting to be Held on 08-05-2023
00.185	2023-04-24	C	Coordination Meeting to be Held on 24-04-2023
00.184	2023-04-17	C	Coordination Meeting to be Held on 17-04-2023
00.183	2023-04-03	C	Coordination Meeting to be Held on 03-04-2023
00.182	2023-03-27	C	Coordination Meeting to be Held on 20-03-2023
00.181	2023-03-13	C	Coordination Meeting to be Held on 13-03-2023
00.180	2023-02-27	C	Coordination Meeting to be Held on 20-02-2023
00.179	2023-02-09	C	Coordination Meeting to be Held on 09-02-2023
00.178	2023-01-30	C	Coordination Meeting to be Held on 30-01-2023
00.177	2023-01-15	C	Coordination Meeting to be Held on 15-01-2023
00.173	2023-01-02	C	Coordination Meeting to be Held on 02-01-2023

**Respective date agenda can be viewed**



# Progress Report & Handing over Module | Modular reports for progress monitoring



## Weekly / Monthly Progress Report

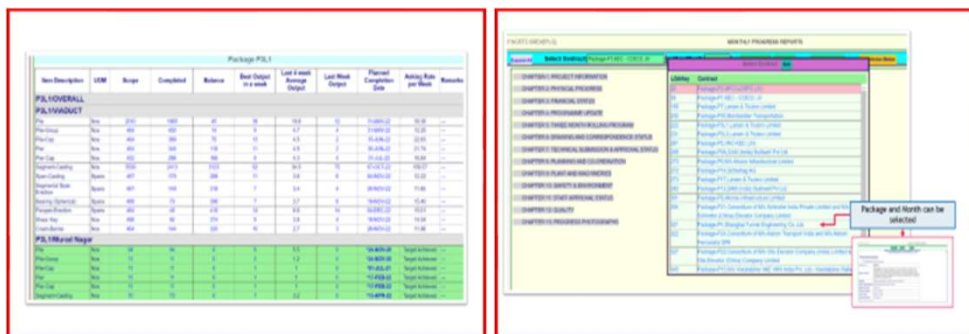

## Interface/ Inter-Dept. Handing over



- Comparison of actual progress against Asking Rate along with Best and Last 4-weeks output
- Complete Online Workflow for Submission of MPR by contractor
- Online review by the concerned person

- Notification generated when any stretch is ready for Handing over
- Department wise Handing over and Readiness status visible
- Request forward option to other dept. for inspection and activity takeover



# Dashboards | Real-time insights for decision-making & timely interventions



Navigation Page

## NCRTC Project Monitoring Dashboard

Civil construction

System Works

Package Summary	P1	P2	P3L1	P3L2	P4	P5A	P5B	P6	
	P7	P8	P9A	P10	P11L1	P11L2	P12A	P12BL1	P12BL2

Viaduct	P1	P2	P3L1	P3L2	P6	P7
---------	----	----	------	------	----	----

Elevated Stations	SHB	GUL	GZB	DUH	MDNRN	RIT	STBN	P RTP	MTS
	MDNRS	MUD	SKK	NASKN	BRMP	MESC	DAURLI	MTN	MDPR

Depot & At-grade Stn(P5A)	DUH Depot	DUH STN
---------------------------	-----------	---------

Staff Quarters(P9A)	Jangpura Complex
---------------------	------------------

Tunnel	P4	P8
--------	----	----

UG Stations	Anand Vihar	Meerut Central	Bhaisali	Begumpul
-------------	-------------	----------------	----------	----------

M Package	
-----------	--

Access Master	Stage1	Stage 2	Stage 3	Stage 4
---------------	--------	---------	---------	---------

4D	
----	--

Package Summary	P13, P14, P15 & P16	P17	P19L1	P19L2	P20		
	P21	P22	P23	P24	P26A	P26B	P30

Signaling & Telecom(P24)	Signaling	Telecom	PSD	LTE
--------------------------	-----------	---------	-----	-----

Traction & Power Supply (P19L1)	ASS	OHE	SCADA	RSS
---------------------------------	-----	-----	-------	-----

Traction & Power Supply (P19L2)	ASS	OHE	SCADA	RSS
---------------------------------	-----	-----	-------	-----

Tracks	Track Work Supply	Mainline Track	Depot Track
--------	-------------------	----------------	-------------

Rolling Stock(P30)	RS Procurement	Ancillary Procurement
--------------------	----------------	-----------------------

Elevators & Escalators	Elevators (P22)	Escalators (P21)
------------------------	-----------------	------------------

AFC	P26A	P26B
-----	------	------

TVS,ECS (P23)	
---------------	--

Solar (P20)	
-------------	--

Stage Wise Progress	Stage 1	Stage 2
---------------------	---------	---------

Pre Construction	
------------------	--

General Dashboard

- Labor Status
- Overall Summary
- Leaderboard
- Finance
- Human Resource
- Procurement
- Issue Register
- Risk & Compliance
- Enablement
- Design (Civil)
- Quality
- HSE
- Contracts
- Refresh Dashboard



# Employee Self Service Module | Empowers employees & brings efficiency & accountability in HR processes



## ESS Module - Online Facilities



Salary slip generation & Income Tax projection



Annual Performance Appraisal Report (APAR)



Online attendance system



Leave Application and Reports



Employee Bills and Claims



Requisition for General items

## Employee Self-Service (ESS) Module

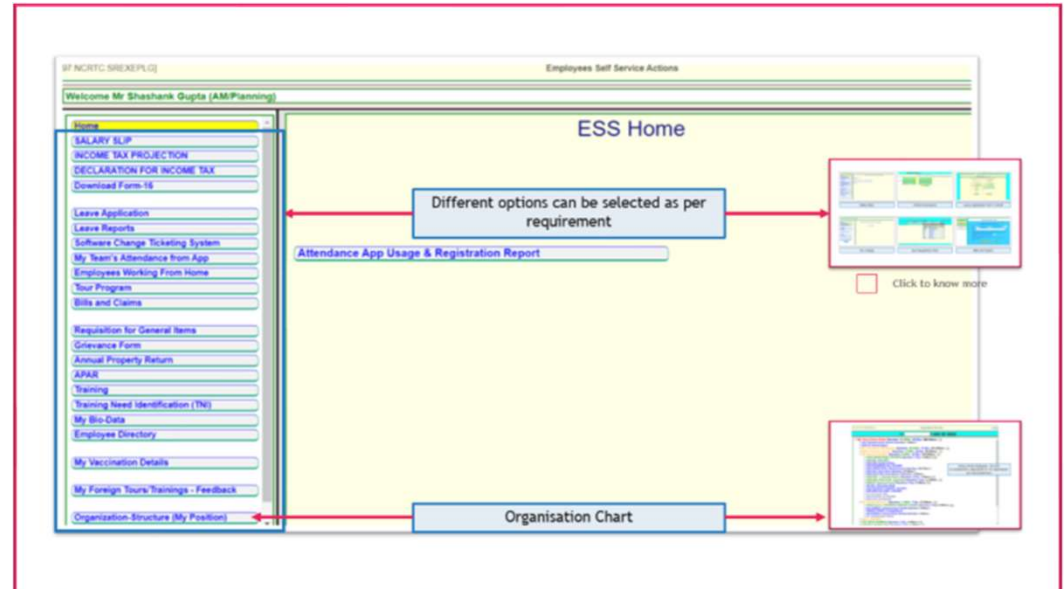



---

# NCRTC MOBILE APPLICATIONS



# GATI App | Custom-made IT solution for HR / Admin activities

## Manage Attendance & Leave



AI based Face Recognition



Apply Geo fencing



Apply & Approve Leave, WFH

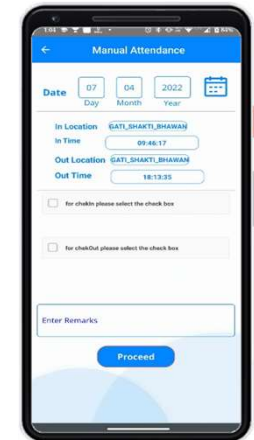
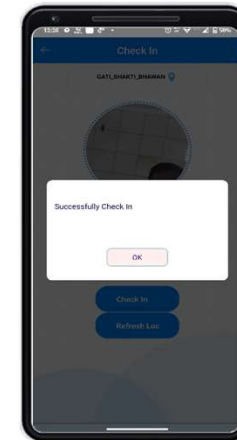
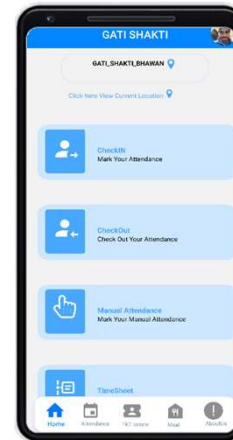

## Perform day to day functions from same app



Can make payment in Canteen



See hospital list and navigate



See Employee directory; raise tickets

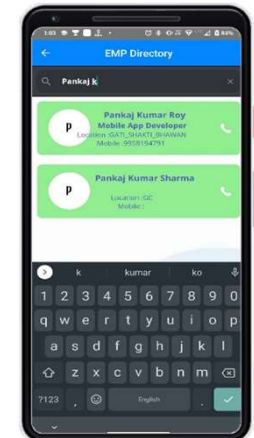
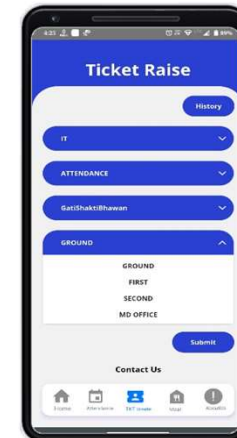
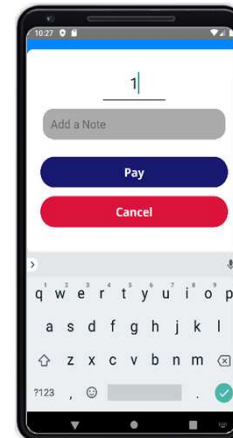

# QC App | Inspect and review the Quality based on day to day construction management

## CRFI (Construction Request for Inspection)

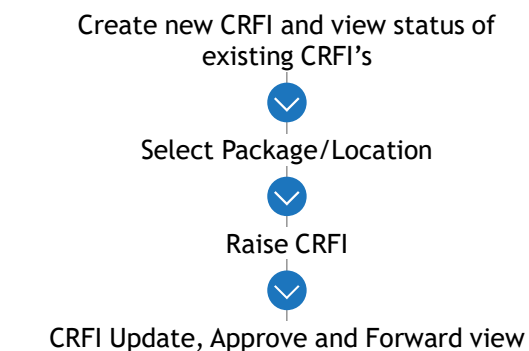
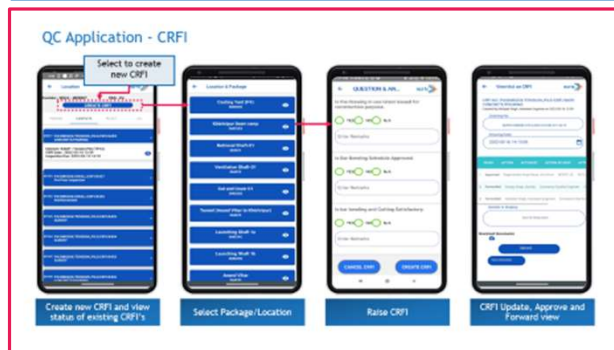

## NCN/NCR (Nonconformity Notice/Report)

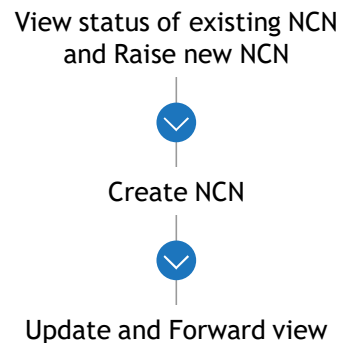
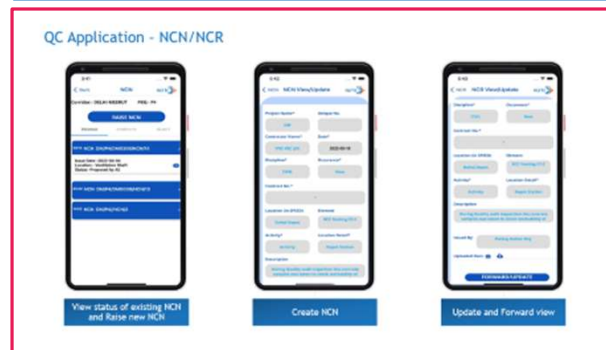

## GC Observation/Inspection

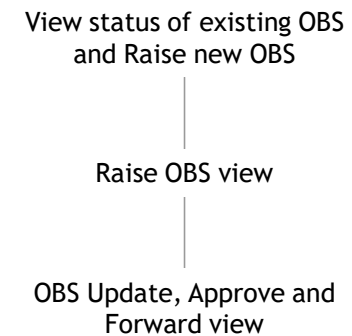
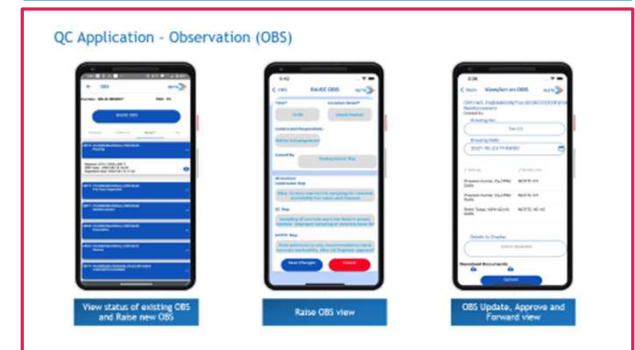

## Technical Stack for SPEED and App | Using the most updated technology enabling use cases across all platforms

	GATI App	SPEED	QC App
<b>Application Type</b>	Native Mobile App	Web Application	Progressive Web Apps
<b>Programming Lang</b>	Java/Kotlin/Swift	PHP/JavaScript	NodeJs
<b>Database</b>	PostgreSQL	PostgreSQL	PostgreSQL
<b>Supporting OS</b>	iOS 11.0 and above Android OS 9.0 to latest	All web-browser support	All web-browser support
<b>Hosting</b>	Compatible with all hyper-scale cloud services		
<b>Designing Tools</b>	Adobe XD, Photoshop CC, Adobe Illustrator CC, Dream Viewer CC, Sketch Design Tool, Invision App Prototype (CC*: Adobe Creative Cloud)		

Quality Tools - Bug Tracking is an integral part of SPEED

# We provide various customizable solutions

	Enterprise	Modular
Features/Deliverables	SPEED with annual subscription & integration	Modules of SPEED with annual subscription
Schedule live demo	Yes	Yes
Access to all modules	All	As per requirement
Integration with other software	Yes	NA
Access to Project Dashboard	Yes	Yes
Training of the workforce	Yes	Yes
Technical Support available	Yes	Yes
Customization as needed	Yes	NA
Access to GATI/QC App	Yes	As per requirement

# SPEED has grown in stature over the years | Audit Certificate

- Audit Certificates - SPEED and Gati App

M/s. SecurEyes Techno Services Pvt. Ltd.  
4th Floor, Delta Block, Sigma Soft Tech Park  
Whitefield Main Road, Varathur Post,  
Bangalore - 560066  
CIN Number: U72900KA2006PTC040519

1134

S/N: SETSPL/2023/95

Security Clearance Certificate for "QUIC" Application	
Hosting URL	<a href="https://www.ncrtc.in/speed">https://www.ncrtc.in/speed</a>
Audit URL	<a href="https://staging.ncrtc.in/fcgi/web/fcm">https://staging.ncrtc.in/fcgi/web/fcm</a>
Environment Details	Apache 2.4.6, Custom Framework, Cent OS 7, PostgreSQL 10.12
Audited By	Silky
Issuing Date	07 <sup>th</sup> April 2023
Valid Till	06 <sup>th</sup> April 2024 (1 Year)
Audit Duration	09 <sup>th</sup> January 2023 to 06 <sup>th</sup> April 2023

**Conclusion**

The above site has undergone Security Audit against OWASP standard and has been found safe from known web vulnerabilities with 15 accepted risks.

**Recommendations**

- 1 Site's '/var/www/fcm' folder must be hosted with the 'Read' permissions.
- 2 The application's '/var/www/fcm' folder is to be deployed over SSL.
- 3 Web server and OS level hardening need to be in place for the production server.
- 4 Directory browsing should be disabled.
- 5 The application should connect with the database using a low privileged database user having minimum required database privileges
- 6 Default and sample applications should be removed from the web server.
- 7 The uploaded files are stored in the Database.
- 8 The application should be upgraded to the latest stable version of Apache during production deployment.
- 9 Credentials used during testing should be mandatorily changed in the production environment.
- 10 SSL/TLS Certificate should be implemented when the website is deployed in the production environment.

**Disclaimer**

This certificate is valid for the period during which the audit was carried out and is subject to audit limitations and relies on stakeholders' assurance provided to us for certain areas as mentioned in the final level report. This is also based on the information and the state of website contents provided for final level audit. Projection of any conclusions based on our findings for future periods and application versions is subject to the risk that the validity of such conclusions may be altered because of changes made to the application or system or the failure to make the changes to the system when required.

**Note**

As per the audit policy, it is essential to refer the website for re-audit on addition/modification of any dynamic content.

**Place:** Delhi  
**Date:** 07 April 2023

[Authorized Signatory]

[Authorized Signatory]

Registered Office  
SecurEyes Techno Services Pvt. Ltd.  
# 3S, 3rd Floor, S1/27, Swamy Towers  
Chinapanahalli, Outer Ring Road,  
Bangalore - 560037

+91-80-41264078/41612612  
info@secureeyes.net  
www.secureeyes.net

M/s. SecurEyes Techno Services Pvt. Ltd.  
4th Floor, Delta Block, Sigma Soft Tech Park  
Whitefield Main Road, Varathur Post,  
Bangalore - 560066  
CIN Number: U72900KA2006PTC040519

1130

S/N: SETSPL/2023/103

Security Clearance Certificate for "GATI iOS" Application	
Hosting Build Name	Gati
Audit Build Name	AttendanceApp.ipa
Environment Details	Android, Apache 2.4.6, PostgreSQL 10.12, React Native, JavaScript
Audited By	Sweta Mohanty & Silky
Issuing Date	07 <sup>th</sup> April 2023
Valid Till	06 <sup>th</sup> April 2024 (1 Year)
Audit Duration	09 <sup>th</sup> January 2023 to 06 <sup>th</sup> April 2023

**Conclusion**

The above site has undergone Security Audit against OWASP standard and has been found safe from known web vulnerabilities with 08 accepted risks.

**Recommendations**

- 1 Site's '/var/www/fcm' folder must be hosted with the 'Read' permissions. 'Execute' permission is not to be given to the application.
- 2 Site '/var/www/fcm' folder is to be deployed over TLS v1.2 or TLS v1.3
- 3 SSL Pinning should be enabled for the android build.
- 4 Web Server and OS level hardening need to be in place for the production server.
- 5 The application should connect with the database using a low privileged database user having minimum required database privileges.
- 6 Default and sample applications should be removed from the web server.
- 7 The uploaded files are stored in the to '/home/PDF/PHOTO' folder which must be enabled with 'Read' & 'Write' Permissions. 'Execute' Permission should not be granted to this folder.
- 8 Credentials used during testing should be mandatorily changed in the production environment
- 9 The application should be upgraded to the latest stable version of Apache during production deployment.

**Disclaimer**

This certificate is valid for the period during which the audit was carried out and is subject to audit limitations and relies on stakeholders' assurance provided to us for certain areas as mentioned in the final level report. This is also based on the information and the state of website contents provided for final level audit. Projection of any conclusions based on our findings for future periods and application versions is subject to the risk that the validity of such conclusions may be altered because of changes made to the application or system or the failure to make the changes to the system when required.

**Note**

As per the audit policy, it is essential to refer the website for re-audit on addition/modification of any dynamic content.

**Place:** Delhi  
**Date:** 07 April 2023

[Authorized Signatory]

[Authorized Signatory]

Registered Office  
SecurEyes Techno Services Pvt. Ltd.  
# 3S, 3rd Floor, S1/27, Swamy Towers  
Chinapanahalli, Outer Ring Road,  
Bangalore - 560037

+91-80-41264078/41612612  
info@secureeyes.net  
www.secureeyes.net

# SPEED has been recognized as one of the best tools in the Indian market







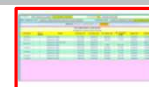



# Team behind the success of SPEED

Idea

Concept

Coordination

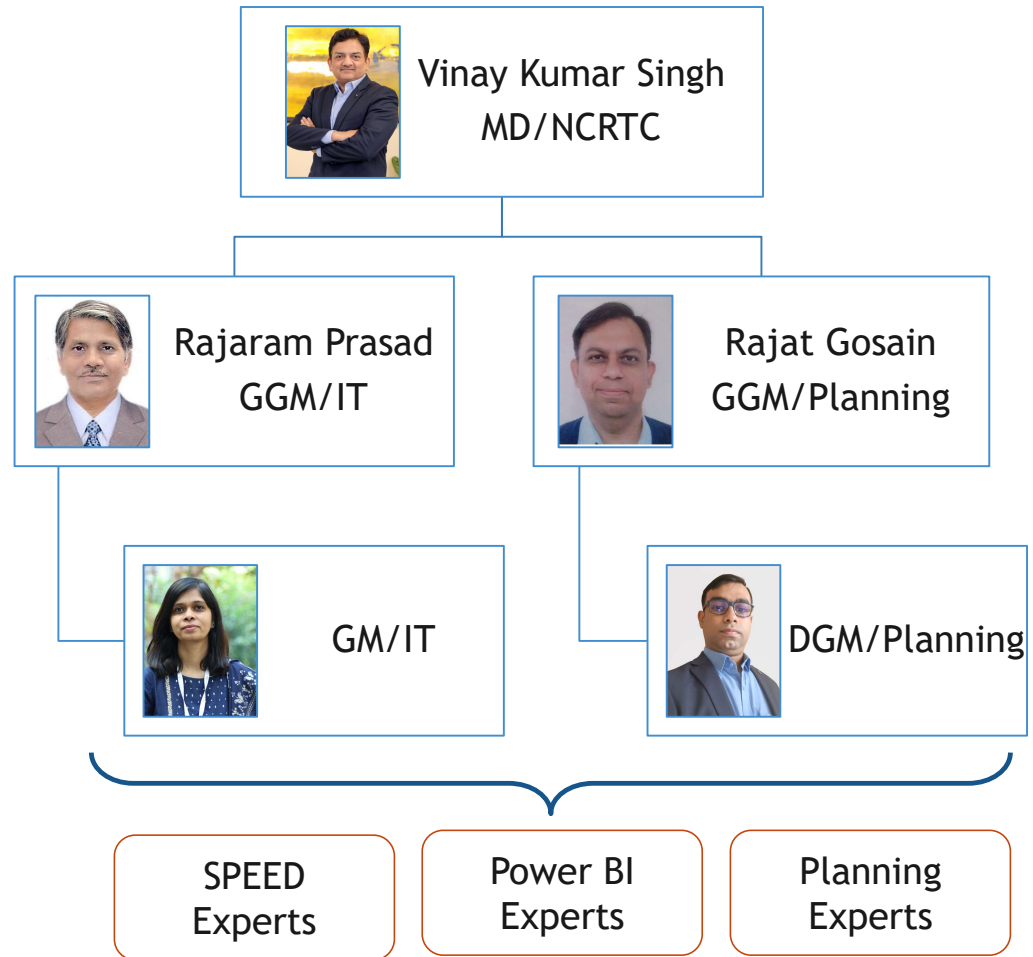
Implementation  
Team



गति से प्रगति

Thank You



National Capital Region Transport Corporation, GatiShakti Bhawan,  
INA, New Delhi - 110023  
Website: [ncrtc.in](http://ncrtc.in)

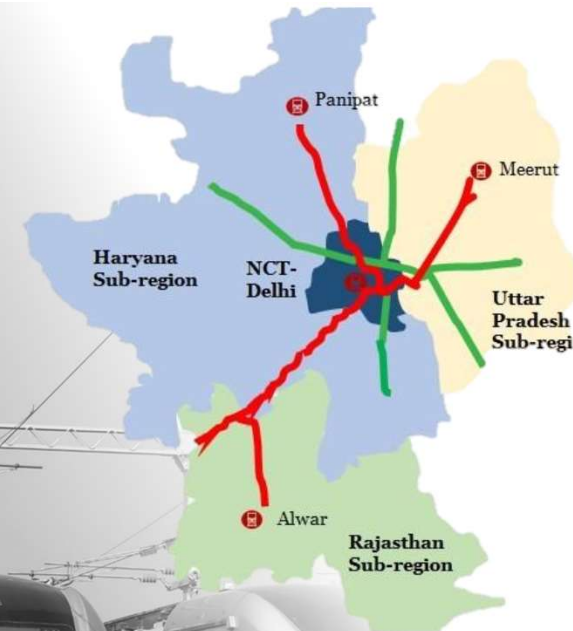

**For queries:**

Rajat Gosain (GGM/Planning)  
+91-8588893409  
[rajat.gosain@ncrtc.in](mailto:rajat.gosain@ncrtc.in)